

E910 E915

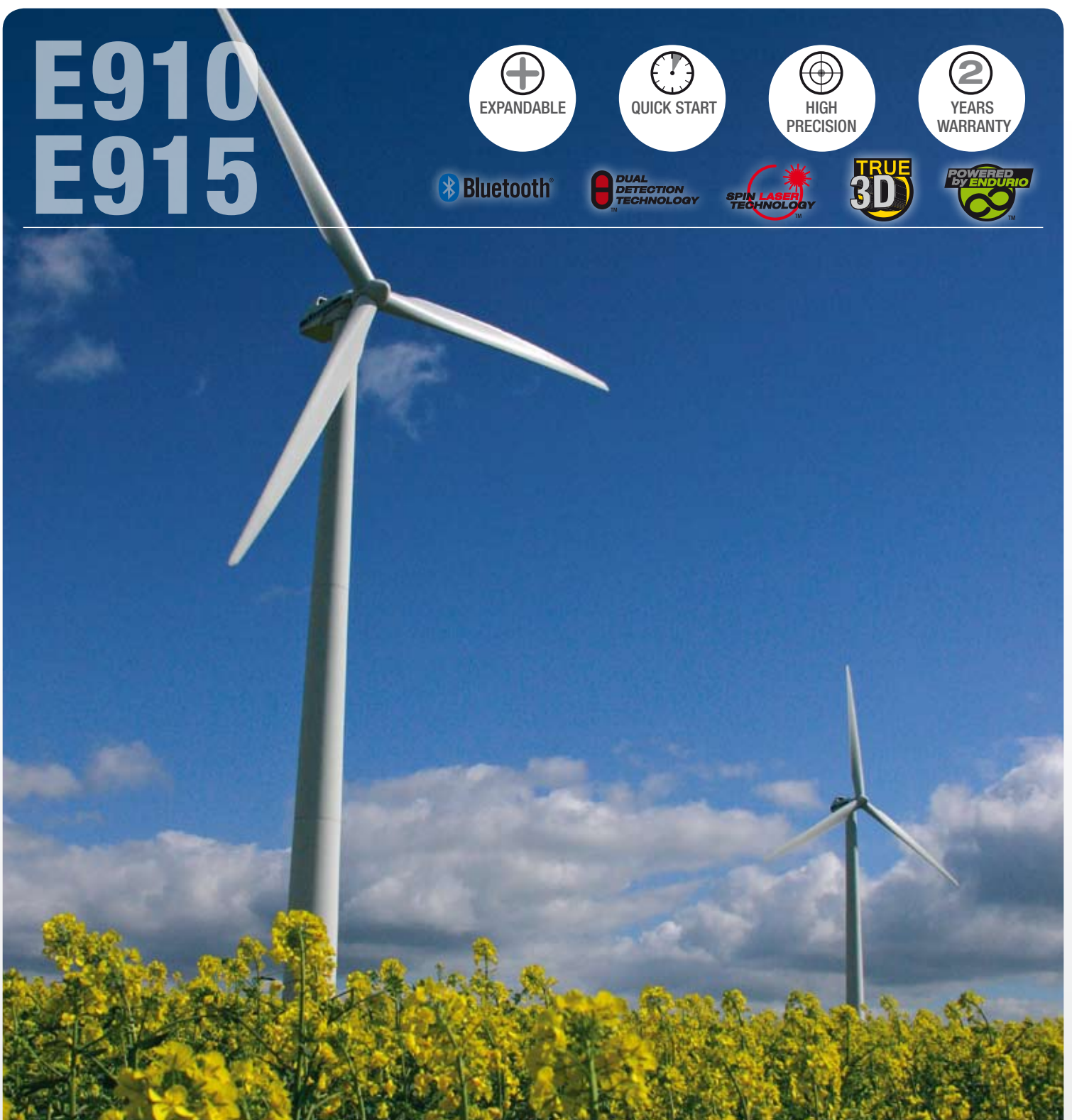

FLANGE MEASUREMENT

For manufacturers in the wind power industry

EASY-LASER®



A PRECISION CHOICE

is also a safe choice!

LONG EXPERIENCE

Easy-Laser® measurement systems have been developed from more than twenty five years experience of solving measurement problems for the industry. This is long enough to understand problems out in the real world. At the same time, we are young enough to see opportunities and solutions with fresh eyes. Taking full control from the initial idea to the finished product and working closely with our users, we are able to create user-friendly measurement systems.

USERS ALL OVER THE WORLD

Easy-Laser® measurement systems are available from local dealers in more than 70 countries, but there are users to be found in many more countries. Easy-Laser® products are used within the wind power generation industry on a daily basis, by companies such as Vestas, Suzlon, Gamesa, and DeWind among others. For them, professional tools and the best possible support are of great importance, and the same is no doubt true for you as well. Service and repair centres can be found all over the world for your convenience. You can be assured that we will provide you with the fastest and best possible support.

LARGE SAVINGS

Easy-Laser® measurement systems are already extremely flexible in their standard form. By using clever accessories, you can adapt the systems for your own needs, now and in the future as your measurement requirements change*. It is cost-effective. Your production capacity increases by being able to measure faster and with greater reliability. Easy-Laser® helps you remedy production errors quickly and easily. This can save you large amounts of money, and your investment can even be repaid within a few months.

ERGONOMIC DESIGN

In order for you, as a user, to be able to focus on the job in hand, it is important that the tools are ergonomic. The display unit has large well-spaced buttons that give clear feedback when pushed. Two Enter buttons make the system suitable for both right and left-handed users. The display screen has clear graphics that guide you through the measurement process.

ANALYSING THE RESULT ON SITE

Easy-Laser® Flange system makes your daily work more efficient. You can see the result as a 3D image in the display unit immediately after measuring. You can evaluate the result with different calculation settings, for example “three point reference”, “best fit” or “all positive”. This can also be done directly on site without having to stop to go to a PC with separate analysis programs, which was the case previously. This makes production much more efficient.

LONG TERM/RELIABLE

Our philosophy is that the products we develop must not only have long operating times but also a long lifecycle. We design our products to be robust, with as few small parts as possible. Measurement systems from Easy-Laser® can withstand rough handling and work without fault in the most demanding environments. Easy-Laser® is the safest choice in all situations.



OUR BEST ARGUMENTS

- Easy to learn and to use
- 2 year warranty provides assurance
- Fast service and support
- Ergonomic design
- Low overall costs during the entire lifecycle of the product, for example servicing, accessories, etc.
- Endurio™ Power management system ensures that you never have to stop in the middle of a measurement because the battery has run out**
- True 3D: you can evaluate the result of the measurement directly in the 3D-image

* At introduction, the E series has limited expandability possibilities.

**Available in the E series display unit.

SIMPLE AND EFFECTIVE



EASY TO USE = FAST AND EFFICIENT

Measurement and alignment should be easy! That is the fundamental philosophy behind our measurement systems. When we talk about simplicity we mean several things, for example, simple to position or install the measurement equipment on the measurement object, easy to perform the measurement and easy to interpret the measurement result. Simple to use = quick and easy! Easy-Laser® Flange system is extremely easy to use and has many time-saving functions that enable you to measure even more flanges during a working day.



Easy-Laser® D23 laser transmitter is positioned directly on the flange. It has a motorised rotating head that creates a continuous laser plane over the entire measurement object, without hidden sectors.



The Easy-Laser® E5 detector is positioned on the measurement point. As the laser beam constantly rotates, you only have to move the detector to each measurement point and register the measurement value. No time wasted repositioning the laser beam.



Once all measurement points have been registered, you can evaluate the results directly in the display unit. This can also be done directly on site without having to stop to go to a PC with separate analysis programs, which was the case previously. This makes production much more efficient.

FLATNESS OF FLANGES

FOR ALL TYPES OF FLANGE

Easy-Laser® Flange systems can be used on all sizes of flanges, regardless of diameter. You can measure 1 to 5 circles of measurement points, for example inner, middle and outer circles, in order to see the taper of the flange. Each circle can have 3–180 measurement points. The program guides you graphically step-by-step through the entire measurement, which quickens the measurement process.

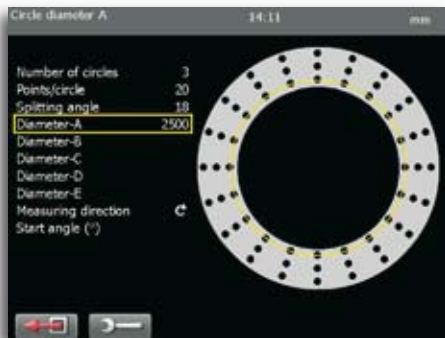
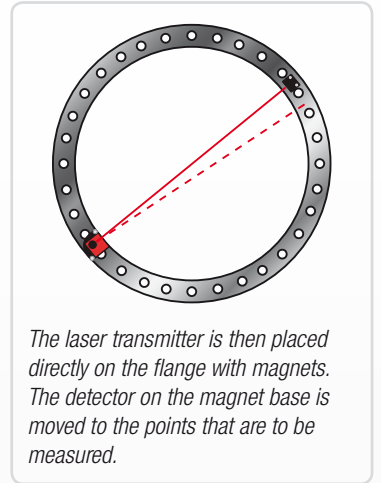

Indicate the number of measurement points and the diameters. You can measure from 1 to 5 circles with measurement points.

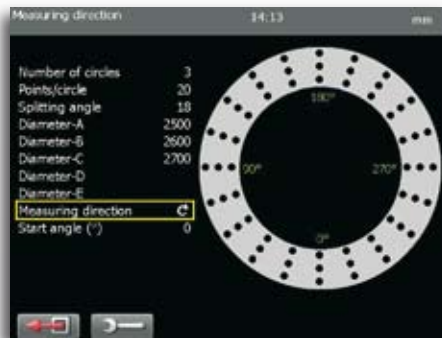

You can select both measurement direction and start point angle.

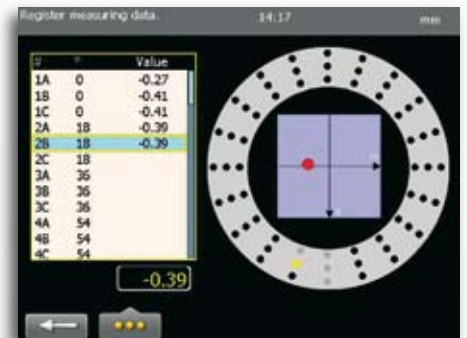

The point to be measured is indicated in the image. It is also possible to see from the display screen whether the laser beam hits the detector.

EVALUATE DIRECTLY ON SITE

When the measurement of the flange is complete, the digits must then be interpreted. Easy-Laser® Flange systems make this extremely easy to do. And you can even do it on site, without having to go to a PC with separate analysis programs. This of course saves a lot of time. Time that you can use to measure more flanges. You can evaluate the result with different calculation settings, for example “three point reference”, “best fit” or “all positive”. The result is shown via graphics in true 3D.

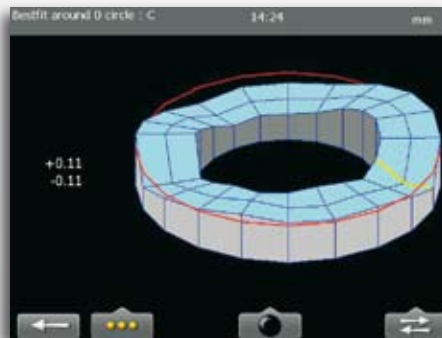

Example of Best fit



Diagram with Min. and Max. values

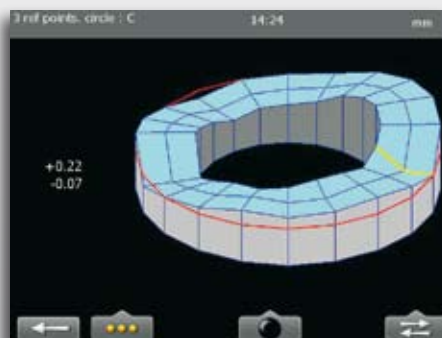

With three reference points



Taper values diagram

PARALLELISM OF TOWER FLANGES

PARALLELISM OF TOWER FLANGES

Easy-Laser® enables you to measure and check the parallelism of the flanges. This can be done in several ways, as shown to the right with system E910 for example. In addition to the standard equipment, two tripods and an angular prism are required.

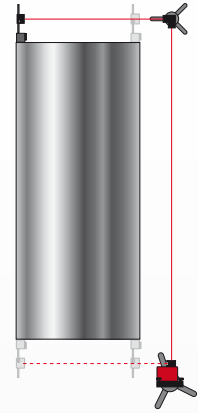
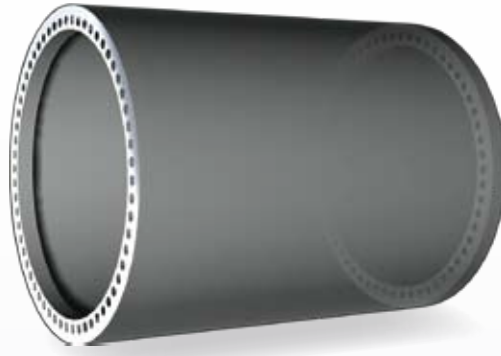

The laser transmitter (D22) is placed on a tripod beside one of the flanges. An angular prism (D46) is placed on a tripod beside the other flange. The detector is then placed on the given measurement points on both flanges.

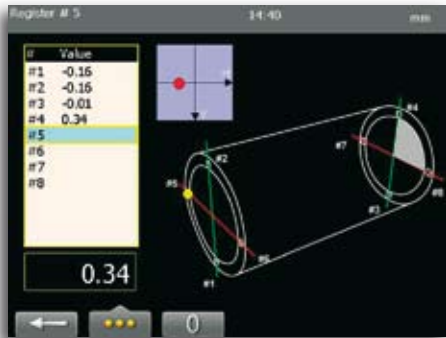

The program guides you step-by-step.

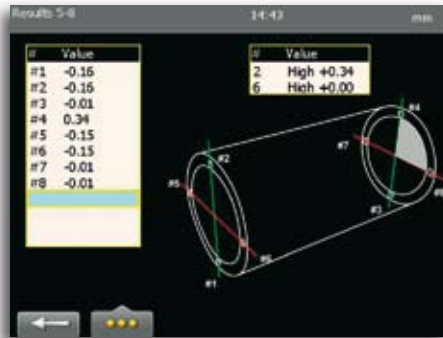

The result clearly shows any parallelism errors between both flanges.

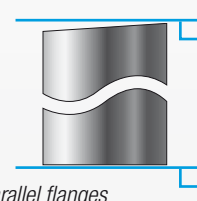

Unparallel flanges



MANY OPTIONS

FLATNESS OF WING FLANGES

To check wing flanges we offer special accessory fixtures. Depending on the construction of the flanges, if they are non-magnetic for example, the fixtures have different designs. Ask us about special solutions for your own designs.

FLATNESS OF HUB FLANGES

The flanges on hubs can be checked in the same way as the tower flanges. No need for extra equipment in addition to what is included in an Easy-Laser® E910/E915 Flange system.

FLATNESS OF FOUNDATIONS

A basic requirement for the machines to work under the right conditions is that the bases they stand on are flat. Easy-Laser® enables you to check this too. No need for extra equipment in addition to what is included in an Easy-Laser® E910/E915 Flange system.



DOCUMENTATION

Create documentation according to your own needs

Your company's logo

Measurement information

Values 2D graph

Taper 2D graph

3D image

Measurement statistics

List of measurement values

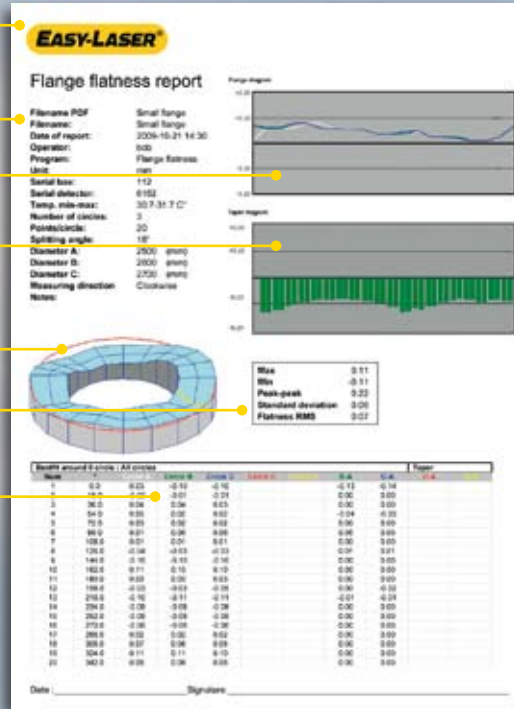

CREATE A PDF REPORT DIRECTLY

It is possible to generate a PDF report containing graphs and measurement data directly in the measurement system's display unit. All the information about the measurement object is documented, and you can add your company's logo and address details if you so wish.



Polar diagram

3D image

List of measurement values

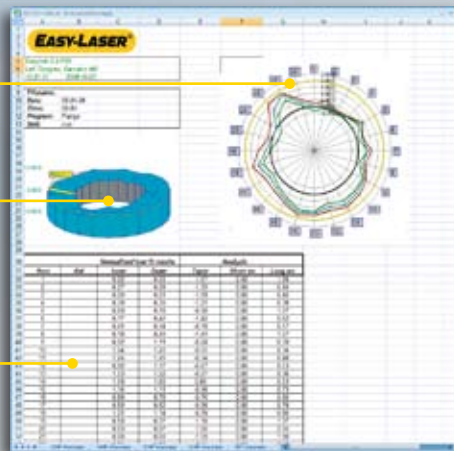

EASYLINK™

The measurement system includes EasyLink™ data base program for Windows® as standard. Here you can collate all your measurements in the same place and also make more advanced calculations, add images, export to Excel® documents etc.



SAVE TO USB MEMORY

You can easily save desired measurements on your USB memory. This enables you to take it to your computer to print reports whilst leaving the measurement system in place to continue measuring.

SAVING IN THE BUILT-IN MEMORY

You can, of course, save all measurements in the display unit's internal memory. You can then open an old measurement and re-measure those points you adjusted, or start from a new measurement avoiding having to enter certain necessary dimensions such as diameter, number of measuring points etc.

CONNECT TO YOUR COMPUTER

The display unit is connected to the computer via the USB port. It then appears on the desktop as a "Mass Storage Device" which you can easily transfer files to and from.

CONNECT EXTERNAL KEYBOARD

Thanks to the USB connector it is possible to connect a range of extra equipment, for example a "proper" keyboard. This facilitates entering more text to the documentation.

THE PARTS OF THE SYSTEM

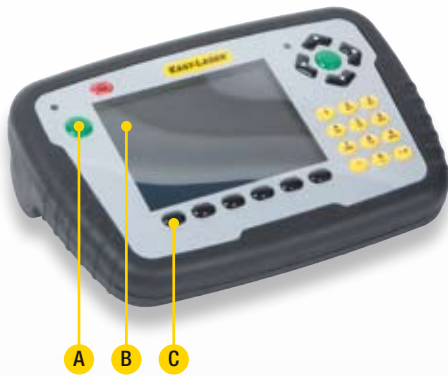

- A. Two Enter buttons, for left and right-handed users
- B. Large, easy to read colour display
- C. Proper buttons for clear feedback



- D. Thin profile gives a perfect grip for your hands
- E. The integrated battery compartment design gives the correct angle on the display screen
- F. Battery compartment
- G. Mounting for shoulder strap

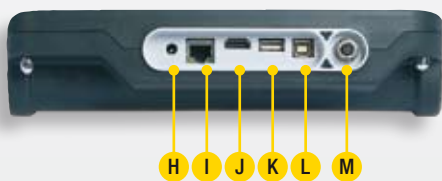

- H. Connection for charger
- I. Network connection
- J. Expansion port
- K. USB A
- L. USB B
- M. Easy-Laser® measurement equipment



- N. Dust and splash guards for connectors that are not used when measuring
- O. Robust, rubber coated design

DISPLAY UNIT

The new display unit for the E series enables you to work more efficiently and for longer than ever before thanks to several innovative solutions. It is also ergonomically designed with easy-to-grip rubber cladding and robust construction.

NEVER LOSE POWER!

The Easy-Laser® E900 series is equipped with our Endurio™ Power management system. This ensures that you never have to stop in the middle of a measurement because the battery has run out. If the internal battery's charge level starts to drop, simply insert the batteries into the integrated battery compartment and continue measuring. This eliminates the need to look for a wall socket, and means you do not have to wait a few hours for the unit to charge before starting work again. Shouldn't it always have been this way? The unique Endurio™ system also checks all the electronics so that the unit consumes as little power as possible in each situation.



PERSONAL SETTINGS

You can create a user profile where you can save your personal settings. You can also have different settings for different types of measurements.

LANGUAGE SELECTION

Initially English, German, French, Spanish and Swedish are available. More languages to follow.

ERGONOMIC

The display unit has a thin, easy-to-grip and rubber coated profile that ensures a secure grip. It has large well-spaced buttons that give clear feedback when pushed. In addition, the two Enter buttons make the system suitable for both right and left-handed users. The display screen has clear graphics that guide you through the measurement process.

VALUES PROGRAM

All our measurement systems come with the extremely useful Values program. With this, you can, in principle, measure any type of geometry, for example straightness and squareness. Many Easy-Laser® users therefore end up using the measurement system in many more places in their operation, than they first intended!



Values program



Calculator

BUILT-IN HELP FUNCTIONS

We have integrated a calculator and conversion tool for length units in the display unit. Another excellent function are the film sequences that help you get started with the measurements if you feel a little rusty.

UPGRADING

If you wish to expand functionality in the future, the software in the display unit can be upgraded via the internet or by connecting a USB memory containing the new software.

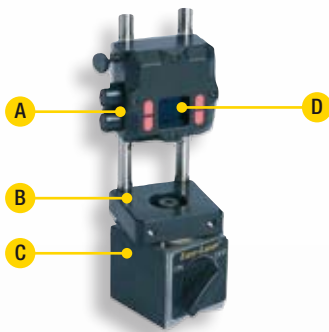

A. Well protected connectors
 B. Rotatable head
 C. Magnet base
 D. PSD (2 axis)



DETECTOR

Detector E5 can work with stationary and rotating lasers (see below) thanks to our Dual Detection Technology™. Connect to the display unit via cable or wirelessly (accessory). The magnet base has a rotating head to align the detector to the laser transmitter. This detector is included in systems E910 and E915.



WIRELESS COMMUNICATION

The unit for wireless communication is easily inserted into one of the connectors on the detector. Wireless connection to the display unit enables you to work more freely. (Accessory)



A. Rotatable head with angular prism
 B. Tilting table

LASER TRANSMITTER D22

Laser transmitter D22 can be used to measure flatness, straightness, squareness and parallelism. The laser beam can sweep 360° with a measurement distance of up to 40 metres [130'] in radius. The laser beam can be angled 90° to the sweep, within 0.01mm/m [0.5 mils/INCH].

This transmitter is included in system E910.

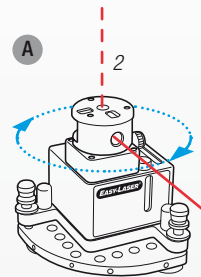

Option 1: the laser beam is used for a 360° sweep.
 Option 2: the laser beam is angled at 90° to the sweep.



A. Rotating head (motor driven)
 B. Tilting table

LASER TRANSMITTER D23 SPIN

Laser transmitter D23 has a motor driven, rotating head that gives a 360° laser plane. Measurement distance up to 20 metres [65'] in radius.

This transmitter is included in system E915.

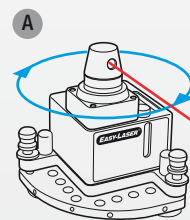

The laser beam is used for a 360° sweep. Because the laser beam sweeps across the surface you do not need to align the beam for every detector position. Convenient!

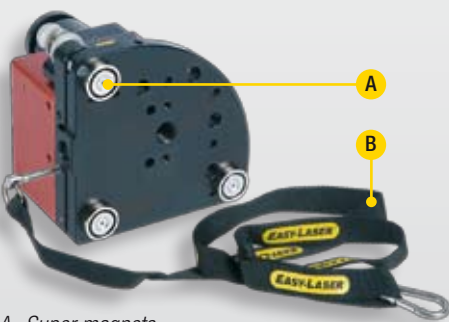

A. Super magnets
 B. Safety strap

POWERFUL ATTACHMENT MAGNETS

Both D22 and D23 laser transmitters are installed against the flange using three super magnets. Hold the transmitter securely, even vertically.

SAFETY STRAP

The safety strap provides good protection against unexpected events, if someone knocks the laser transmitter for example. Easy to attach, through a bolt hole for example.

EXPANDABILITY

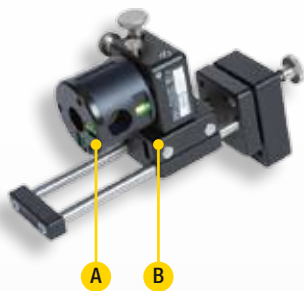

A. Angular prism, rotates 360°
B. Sliding sled

ANGULAR PRISM

Angular prism D46 is used for parallelism measurement of the flanges. It deflects the laser beam 90°.

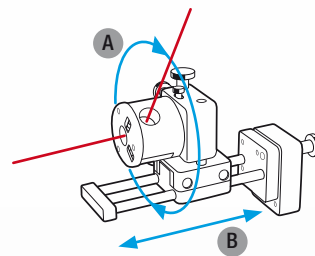

A. With the rotatable angular prism you can reach the detector anywhere on the flange.
B. It is quick and easy to align the beam with the detector using the sled.



TRIPOD

Tripod for use with angular prism D46 and laser transmitter D22/D23.

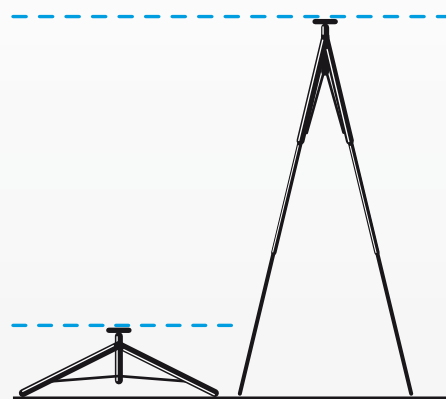

The height of the tripod can be adjusted between 500 and 2730 mm.

WING FLANGE FIXTURES

To check the wing flange flatness, we have various different fixtures. The biggest difference depends on whether the flange is magnetic or not. Contact us for further information.



TECHNICAL DATA

System	
Relative humidity	10–95%
Weight (complete system)	12.1 kg [26.7 lbs]
Carrying case	WxHxD: 550x450x210 mm [21.6x17.7x8.3"] Drop tested. Water and dust tight.

Laser transmitter D22 (system E910)	
Type of laser	Diode laser
Laser wavelength	635–670 nm, visible red light
Laser Safety Class	Class 2
Output	< 1 mW
Beam diameter	6 mm [1/4"] at aperture
Working area, range	40-metre radius [130']
Type of battery	1 x R14 (C)
Operating time/battery	approx. 24 hours
Operating temperature	0–50 °C
Levelling range	± 30 mm/m [± 1.7"]
3 x spirit vials' scaling	0.02 mm/m
Squareness between laser beams	0.01 mm/m [2 arc sec.]
Flatness of sweep	0.02 mm
Fine turning	0.1 mm/m [20 arc sec.]
2 x spirit vials for rotation	5 mm/m
Housing material	Aluminium
Dimensions	WxHxD: 139x169x139 mm [5.47x6.64x5.47"]
Weight	2650 g [5.8 lbs]

Laser transmitter D23 (system E915)	
Type of laser	Diode laser
Laser wavelength	635–670 nm, visible red light
Laser Safety Class	Class 2
Output	< 1 mW
Beam diameter	6 mm [1/4"] at aperture
Working area, range	20-metre radius [65']
Type of battery	2 x R14 (C)
Operating time/battery	approx. 15 hours
Operating temperature	0–50 °C
Levelling range	± 30 mm/m [± 1.7"]
3 x spirit vials' scaling	0.02 mm/m
Flatness of sweep	0.02 mm
Housing material	Aluminium
Dimensions	WxHxD: 139x169x139 mm [5.47x6.64x5.47"]
Weight	2650 g [5.8 lbs]

Detector E5	
Type of detector	2 axis PSD 20x20 mm [0.78" sq]
Dual Detection Technology™	Can detect both spinning and stationary laser beam
Resolution	0.001 mm [0.05 mils]
Measurement error	± 1% +1 digit
Inclinometers	0.1° resolution
Thermal sensors	± 1° C accuracy
Environmental protection	IP Class 66 and 67
Operating temperature	-10–50 °C
Internal battery	Li Po
Housing material	Anodized aluminium
Dimensions	WxHxD: 60x60x42 mm [2.36x2.36x1.65"]
Weight	186 g [6.6 oz]

Display unit	
Measuring programs	Flange flatness / Flange parallelism / Values
Type of display/size	VGA 5.7" colour
Displayed resolution	0.001 mm / 0.05 thou
Power management	Endurio™ system for unbroken power supply
Internal battery (stationary)	Li Ion
Battery compartment	For 4 pcs R 14 (C)
Operating time	Appr. 30 hours (Normal operating cycle)
Operating temperature	-10–50 °C
Connections	USB A, USB B, External, Easy-Laser® units, Network
Storage memory	>100,000 measurements
Help functions	Calculator, Unit converter, Instruction films
Environmental protection	IP Class 65
Housing material	ABS / PC / TPE
Dimensions	WxHxD: 250x175x63 [9.8x6.9x2.5"]
Weight (without batteries)	1030 g [2.3 lbs]

Wireless connection unit (optional)	
Wireless communication	Class II Bluetooth® Wireless Technology
Operating temperature	-10–50 °C
Environmental protection	IP Class 66 and 67
Housing material	ABS
Dimensions	53x32x24 mm [2.1x1.2x0.9"]
Weight	25 g [0.9 oz]

Cables	
Type	With Push/Pull connectors
System cable	Length 2 m [78.7"]
Extension system cable	Length 5 m [196.8"]
USB cable	Length 1.8 m [70.8"]

Magnet base with turnable head (for detector)	
Holding power	800 N

Rods for detector	
Length	60 mm / 120 mm (extendable) [2.36"/4.72"]

EasyLink™ data base software for PC	
Minimum requirements	Windows® 95 or later 256 Mb RAM, 5 Mb free hard drive space

A complete system contains (*optional equipment)	
1	Laser transmitter D22 (only system E910)
1	Laser transmitter D23 (only system E915)
1	Detector E5
1	Display unit
1*	Bluetooth unit
1	Cable 2 m
1	Cable 5 m (extension)
1	Cable support
1	Safety strap for laser transmitter
2	Targets for rough alignment
1	Magnet base with turnable head
1	Set of rods (6x60 mm, 6x120 mm)
1	Manual
1	Quick manual
1	Measuring tape 5 m
1	USB memory stick
1	USB cable
1	Battery charger (100–240 V AC)
2	Batteries Alkaline R14
1	Toolbox
1	Cleaning cloth for optics
1	EasyLink™ Windows® program (CD)
1	Carrying case

System Easy-Laser® E910 Flange, Part No. 12-0525

System Easy-Laser® E915 Flange, Part No. 12-0526





LONG WARRANTY PERIOD

The Easy-Laser® systems are developed with the backing of more than 25 years' experience of solving measurement and alignment problems for the industry, all over the world.



The systems come with a generous two year warranty. The manufacturing and quality systems are approved according to ISO9001.

QUICK SERVICE

Our service department usually takes care of servicing or calibration within five working days. All this makes Easy-Laser® a safer working partner for your operation. As an extra service, we provide a 48 hour express service for when accidents occur and time is of the essence. Contact us for further information about terms and conditions.



IN-HOUSE EXPERTISE

We take care of the entire chain internally, from idea to the end product. Our development department consists of designers who specialise in mechanics, electronics, optics and programming.

CLEVER CONSTRUCTION

Our development department continuously strives to simplify the user's work through innovative and clever solutions. It is the collaboration between laser transmitter, detector and software that is the key to a quick and easy measurement. This is where Easy-Laser® shines.

CUSTOM DESIGN

In addition to our already versatile standard system we can also specially adapt measurement systems to suit your needs, something we are proud of being able to offer. Using our own CNC machines we can quickly manufacture fixtures just for you.

Easy-Laser® is manufactured by Damalini AB, Åbäcksgatan 6B, SE-431 67 Mölndal, Sweden

Tel +46 (0)31 708 63 00, Fax +46 (0)31 708 63 50

e-mail: info@damalini.se, www.damalini.com

© 2009 Damalini AB. We reserve the right to make changes without prior notification.

Easy-Laser® is a registered trademark of Damalini AB.

Other trademarks belong to the relevant copyright holder.

This product corresponds to: SS-EN60825-1-1994, 21 CFR 1040.10 and 1040.11

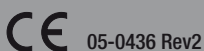

Авторизованный дилер на территории Республики Беларусь

ИП Авдонин А.В.

T/ф +37517-220-83-91, Моб.+37529-378-25-01, +37529-708-01-91

www.vibrohelp.by, e-mail: vibrohelp@tut.by